

**RX-4109**  
**AM/FM STEREO RECEIVER**





OPERATING INSTRUCTIONS

---



***RX-4109***  
***AM/FM STEREO RECEIVER***



# Introduction

## READ THIS BEFORE OPERATING YOUR UNIT

	<b>CAUTION</b> RISK OF ELECTRIC SHOCK DO NOT OPEN	
<b>CAUTION</b> : TO REDUCE THE RISK OF ELECTRIC SHOCK, DO NOT REMOVE COVER (OR BACK). NO USER-SERVICEABLE PARTS INSIDE. REFER SERVICING TO QUALIFIED SERVICE PERSONNEL.		

	This symbol is intended to alert the user to the presence of uninsulated "dangerous voltage" within the product's enclosure that may be of sufficient magnitude to constitute a risk of electric shock to persons.
	This symbol is intended to alert the user to the presence of important operating and maintenance (servicing) instructions in the literature accompanying the appliance.

**WARNING** : TO REDUCE THE RISK OF FIRE OR ELECTRIC SHOCK, DO NOT EXPOSE THIS APPLIANCE TO RAIN OR MOISTURE.

### Caution regarding installation

Note : For heat dispersal, do not install this unit in a confined space such as a bookcase or similar enclosure.

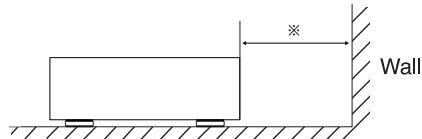
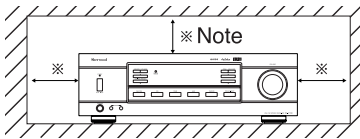

**Do not block ventilation openings or stack other equipment on the top.**

## FOR YOUR SAFETY

EUROPE  
AUSTRALIA

220 V  
-  
240 V

To ensure safe operation, the three-pin plug supplied must be inserted only into a standard three-pin power point which is effectively earthed through the normal household wiring. Extension cords used with the equipment must be three-core and be correctly wired to provide connection to earth. Improper extension cords are a major cause of fatalities. The fact that the equipment operates satisfactorily does not imply that the power point is earthed and that the installation is completely safe. For your safety, if in any doubt about the effective earthing of the power point, consult a qualified electrician.

PAN-EUROPEAN UNIFIED VOLTAGE  
All units are suitable for use on supplies 220-240 V AC.

## CAUTION

- Leave a space around the unit for sufficient ventilation.
- Avoid installation in extremely hot or cold locations, or in an area that is exposed to direct sunlight or heating equipment.
- Keep the unit free from moisture, water, and dust.
- Do not let foreign objects in the unit.
- The ventilation should not be impeded by covering the ventilation openings with items, such as newspapers, table-cloths, curtains, etc.
- No naked flame sources, such as lighted candles, should be placed on the unit.
- Please be care the environmental aspects of battery disposal.
- The unit shall not be exposed to dripping or splashing for use.
- No objects filled with liquids, such as vases, shall be placed on the unit.
- Do not let insecticides, benzene, and thinner come in contact with the set.
- Never disassemble or modify the unit in any way.
  - Notes on the AC power cord and the wall outlet.
- The unit is not disconnected from the AC power source(mains) as long as it is connected to the wall outlet, even if the unit has been turned off.
- When disconnecting the power cord from the wall outlet, always pull the plug, not the power cord.
- Disconnect the plug from the wall outlet when not using the unit for long periods of time.
- The wall outlet shall be installed near the unit and shall be easily accessible.

### Note on recycling

This product's packaging materials are recyclable and can be reused. Please dispose of any materials in accordance with the local recycling regulations.

When discarding the unit, comply with local rules or regulations.

Batteries should never be thrown away or incinerated but disposed of in accordance with the local regulations concerning chemical waste.

This product and the accessories packed together constitute the applicable product according to the WEEE directive except batteries.



# CONTENTS

Introduction	
• READ THIS BEFORE OPERATING YOUR UNIT.....	2
System Connections .....	4
Front Panel & Remote Controls .....	7
• REMOTE CONTROL OPERATION RANGE .....	9
• LOADING BATTERIES .....	9
Operations	
• LISTENING TO A PROGRAM SOURCE .....	10
• LISTENING TO RADIO BROADCASTS .....	13
• LISTENING TO RDS BROADCASTS (FM ONLY) .....	16
(RDS Tuner (Regional Option for some countries in Europe, etc))	
• RECORDING .....	19
• OTHER FUNCTIONS .....	20
Troubleshooting Guide .....	21
Specifications .....	22

# System Connections

- Do not plug the AC input cord into the wall AC outlet until all connections are completed.
- Be sure to connect the white RCA pin cords to the L (left) and the red RCA pin cords to the R (right) jacks when making audio connections.
- Make connections firmly and correctly. If not, it can cause loss of sound, noise or damage to the receiver.
- If the electricity fails or the AC input cord is left unplugged for more than several days, the memorized contents will be cleared. Should this happen, memorize them again.

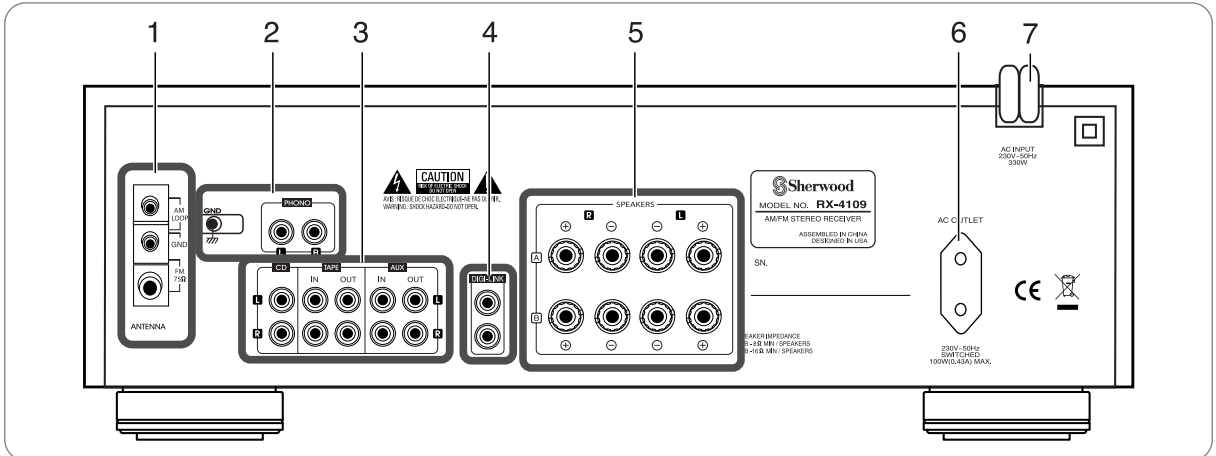

## 1. CONNECTING ANTENNAS

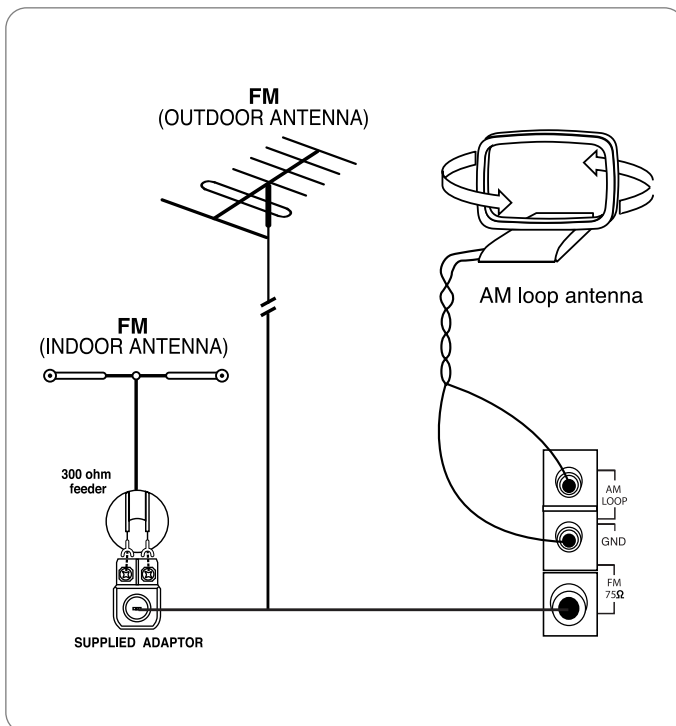

- Change the position of the FM indoor antenna until you get the best reception of your favorite FM stations.
- A 75Ω outdoor FM antenna may be used to further improve the reception. Disconnect the indoor antenna before replacing it with the outdoor one.
- Place the AM loop antenna as far as possible from the receiver, TV set, speaker cords and the AC input cord and set it to a direction for the best reception.
- If the reception is poor with the AM loop antenna, an AM outdoor antenna can be used in place of the AM loop antenna.

## 2. CONNECTING PHONO

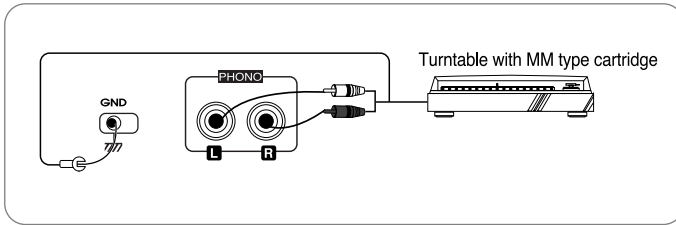

■ Note

- Do not connect the turntable with MC type cartridge directly. If so, use a separate head amplifier or step-up transformer.

## 3. CONNECTING AUDIO COMPONENTS

- The AUX jacks may also be connected to an additional component such as MD recorder, tape deck, etc.

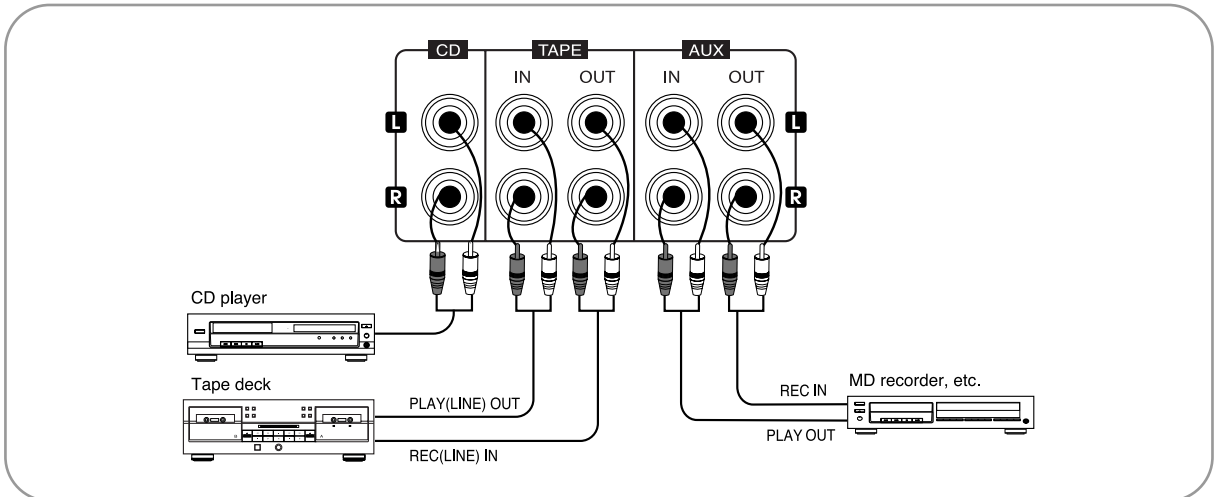

## 4. CONNECTING DIGI-LINK

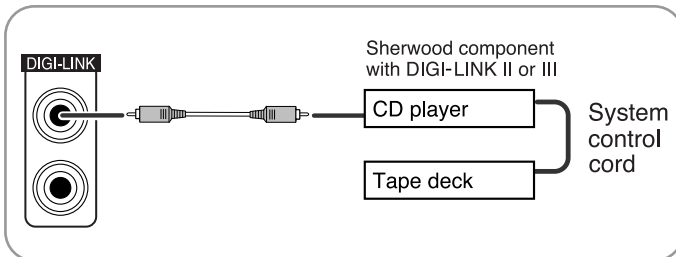

- Connect this jack to the DIGI-LINK jack of the external Sherwood component that uses the DIGI-LINK II or III remote control system.

## 5. CONNECTING SPEAKERS

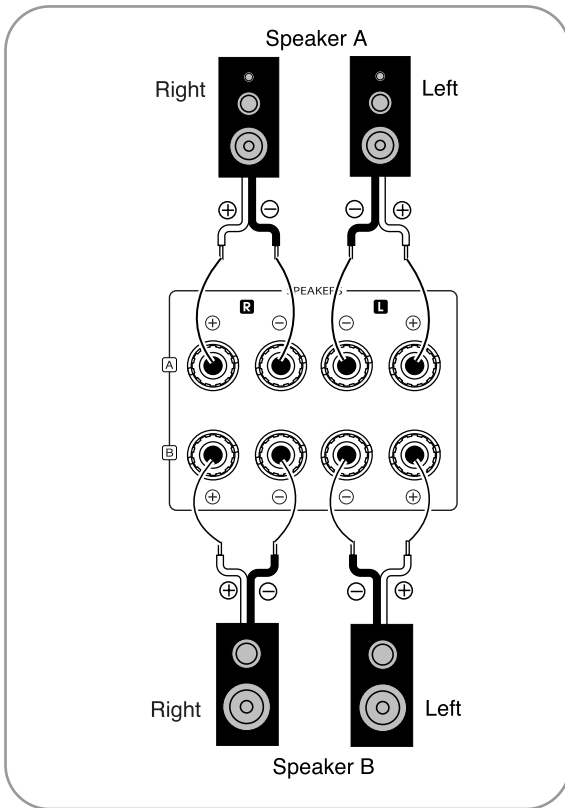

- Usually SPEAKER A terminals are used for only a pair of speakers. When you have another pair of speakers, SPEAKER B terminals can be used.
- Never short-circuit the + and - speaker cords.
- Be sure to connect speakers firmly and correctly according to the channel (left and right) and the polarity (+ and -).

### ■ Note

- For safe amplifier operation, use the speakers with impedance of over  $8\Omega$  when you use only SPEAKER A or B terminals and use the speakers with impedance of over  $16\Omega$  when you use both SPEAKER A and B terminals.

## 6. SWITCHED AC OUTLET

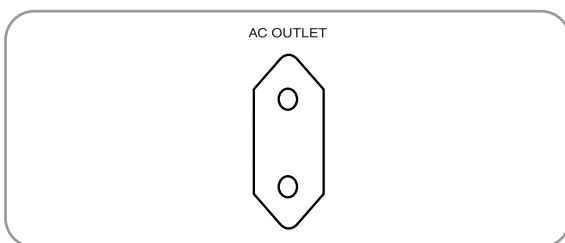

- This outlet is switched on (power-on mode) and off (standby mode) according to power control as follows (Maximum total capacity is 100 W (0.43A)).

Standby mode - Switched AC outlet off   
 Power-on mode - Switched AC outlet on

## 7. AC INPUT CORD

- Plug the cord into a wall AC outlet.

# Front Panel & Remote Controls

## FRONT PANEL

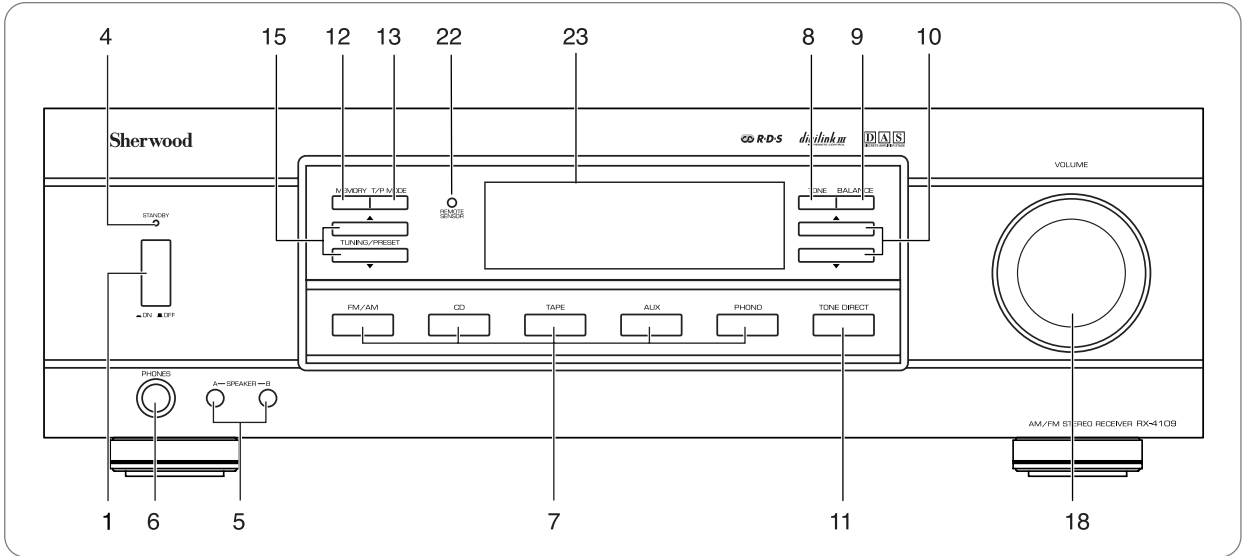

## REMOTE CONTROLS

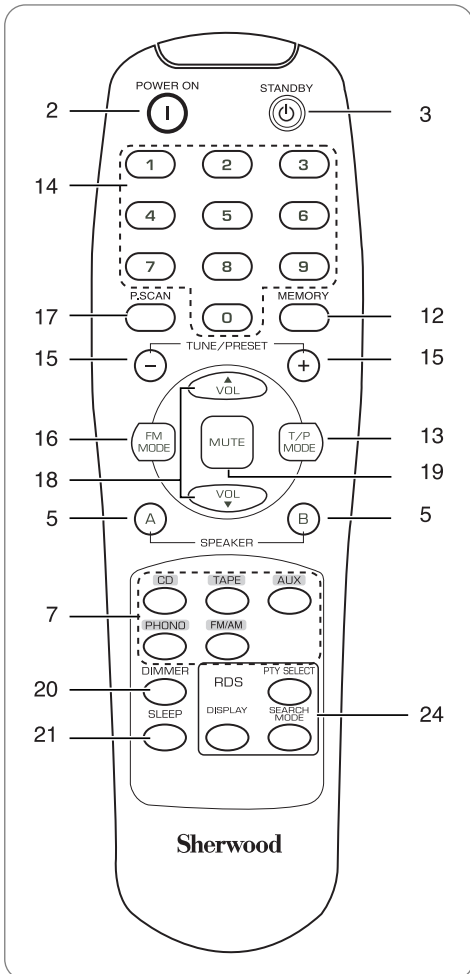

## FLUORESCENT DISPLAY

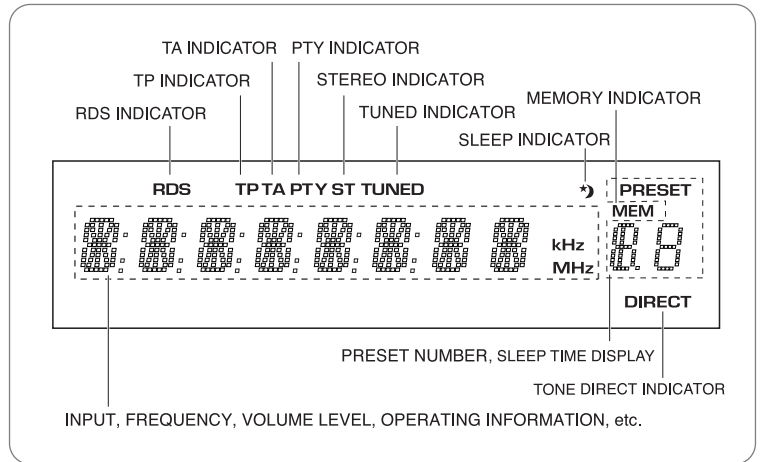



1. **POWER SWITCH**  
Push this switch to enter the standby mode.  
To switch the power off, push again this switch.
2. **POWER ON BUTTON**  
In the standby mode, press this button, then this unit is turned on to enter the operating mode.
3. **STANDBY BUTTON**  
In the operating mode, press this button then this unit is turned off to enter the standby mode.
4. **STANDBY INDICATOR**
5. **SPEAKER A, B SELECTOR BUTTONS**  
These buttons allow you to select various combinations of speakers as follows:
  - To drive A speakers, press only the SPEAKER A button ("SPK A" is displayed).
  - To drive B speakers, press only the SPEAKER B button ("SPK B" is displayed).
  - To drive both A and B speakers, press the SPEAKER A(or B) and B(or A) buttons in order. ("SPK A B" is displayed).
  - When using headphones for private listening, press these buttons in order to switch off the speaker A and B ("SPK OFF" is displayed).
6. **HEADPHONE JACK**  
Stereo headphones with a standard 1/4 inch plug can be plugged into this jack for private listening.
7. **INPUT SELECTOR BUTTONS**  
Press the button to select the desired input source.
8. **TONE BUTTON**  
When adjusting the tone (bass and treble), press this button to select the desired tone mode.
  - Each time this button is pressed, the tone mode is changed to bass or treble.
9. **BALANCE BUTTON**  
When adjusting the sound volume balance, press this button to enter the balance mode.
10. **BALANCE, TREBLE/BASS UP/DOWN (▲/▼) BUTTONS**  
At the balance mode, adjust the sound volume balance between left and right speakers with these buttons.  
At the desired tone mode, adjust the tone as desired with these buttons.
11. **TONE DIRECT BUTTON**  
Press this button to listen to a program source without the tone effect.
12. **MEMORY BUTTON**  
Press this button to store preset stations.
13. **TUNING/PRESET MODE BUTTON**  
Press this button to select the tuning mode or the preset mode.
14. **NUMERIC BUTTONS (0 ~ 9)**  
Press these buttons to select or to store preset stations directly.
15. **TUNING/PRESET UP/DOWN (▲, + / ▼, -) BUTTONS**  
Press these buttons to tune in the desired stations.
16. **FM MODE BUTTON**  
Press this button to select the desired FM mode.
  - Each time this button is pressed, the FM mode is changed to the stereo mode or the mono mode.
17. **PRESET SCAN BUTTON**  
Press this button to scan the stations in the preset sequence.
18. **VOLUME CONTROL KNOB, UP/DOWN (▲/▼) BUTTONS**  
Adjust the volume to a comfortable listening level with this knob or these buttons.
19. **MUTE BUTTON**  
Press this button to temporarily mute the sound.  
Press again to resume the previous sound level.
20. **DIMMER BUTTON**  
Press this button to select the brightness of the fluorescent display as desired.
  - Each time this button is pressed, the brightness of the fluorescent display changes as follows:  

→ ON → dimmer → OFF
21. **SLEEP BUTTON**  
Press this button to activate the sleep timer for a specified period of time.
  - Each time this button is pressed, the sleep time changes as follows:  

→ 10 → 20 → 30 → 60 → 90 → OFF
 

Unit : minutes
22. **REMOTE SENSOR**  
This receives the signals from the remote control unit.
23. **FLUORESCENT DISPLAY**  
For details, see the previous page.
24. **RDS BUTTONS (Regional option for Europe, etc.)**  
Use these buttons when listening to RDS broadcast.  
For more information, refer to pages 16~18.

## REMOTE CONTROL OPERATION RANGE

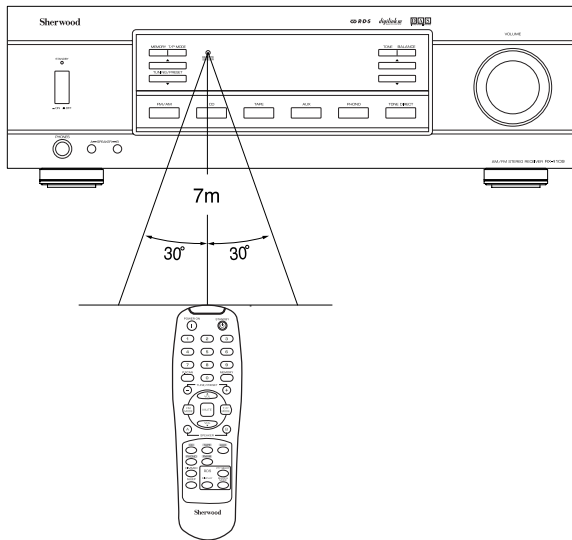

- Use the remote control unit within a range of about 7 meters (23 feet) and angles of up to 30 degrees aiming at the remote sensor.

## LOADING BATTERIES

1. Remove the cover.

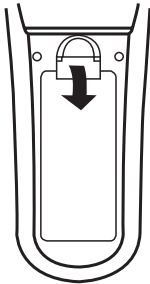

2. Load two batteries matching the polarity.

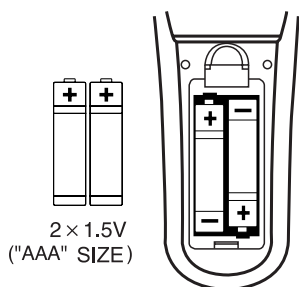

- Remove the batteries when they are not used for a long time.
- Do not use the rechargeable batteries(Ni-Cd type).

# Operations

## LISTENING TO A PROGRAM SOURCE

### Before operation

- Push the POWER switch.

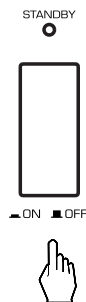

- This unit enters the standby mode and the STANDBY indicator lights up. This means that the receiver is not disconnected from the AC mains and a small amount of current is retained to support the memorized contents and operation readiness.
- To switch the power off, push the POWER switch again. Then the power is cut off and the STANDBY indicator goes off.

### 1. In the standby mode, turn the power on.

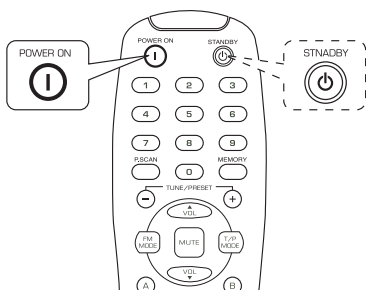

- When the POWER ON button on the remote control is pressed, this unit is turned on to enter the operating mode.
- In the standby mode, if an INPUT SELECTOR button on the remote control or the front panel is pressed, the unit is turned on automatically and the desired input is selected.
- In the operating mode, when the STANDBY button on the remote control is pressed, then it enters the standby mode.

### 2. Switch the desired speakers on.

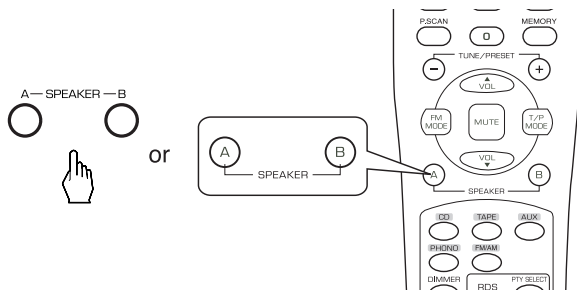

- Then the corresponding speaker indication ("SPK A(or/and) B") is displayed and the sound can be heard from the speakers connected to the selected speaker terminals.
- When using the headphones for private listening, press the corresponding SPEAKER button to switch off both A and B speakers.

### 3. Select the desired input source.

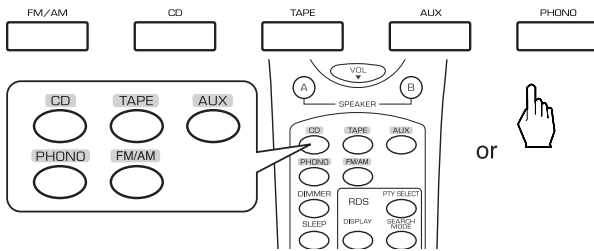

- Each time the FM/AM button is pressed, the band is changed to AM or FM.

### 4. Operate the selected component for playback.

### 5. Adjust the volume to a comfortable listening level.

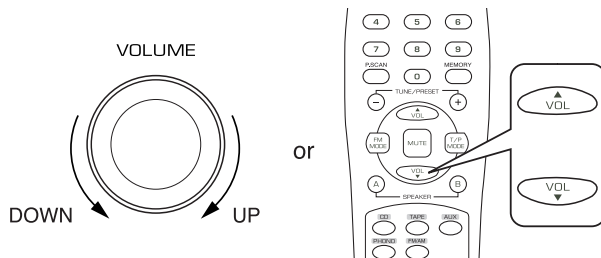

### 6. To mute the sound.

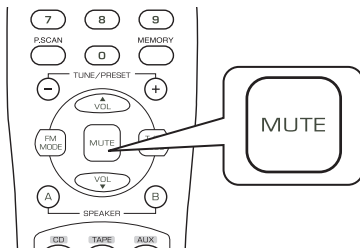

- "MUTE" flickers.
- To resume the previous sound level, press this button again.

### 7. To listen with the headphones.

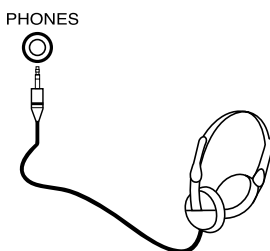

- Be sure to switch off both A and B speakers.

---

## Adjusting the tone (bass and treble)

---

8. Enter the tone mode.

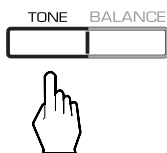

- Each time this button is pressed, the corresponding tone mode is selected and shown for 3 seconds as follows:

→ BASS → TRBL →

- Note:
  - When the tone direct function is activated, the tone mode cannot be entered and "TON DIR" flickers for 2 seconds.

9. At the desired tone mode, adjust the tone as desired.

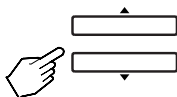

- If the tone display disappears, start from the step 8 again.
- Notes:
  - Extreme settings at high volume may damage your speakers.
  - In general, the bass and treble levels are adjusted to 0.

10. To listen to a program source without the tone effect.

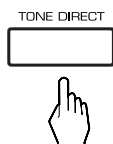

- "TON DIR" is displayed, "DIRECT" lights up and the sound that bypasses the tone circuitry will be heard.
- To cancel the tone direct function, press this button again to display "TON CTRL", and then "DIRECT" goes off.

---

## Adjusting the sound volume balance

---

11. Enter the balance mode.

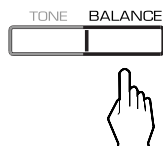

- "BAL" and the balance level is displayed for 3 seconds.

12. Adjust the sound volume balance between the left and right speakers.

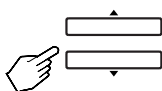

- If the balance display disappears, start from the step 11 again.
- Note:
  - In general, the balance level is adjusted to 0.

# LISTENING TO RADIO BROADCASTS

## Auto tuning

1. Select the tuner and then the desired band.

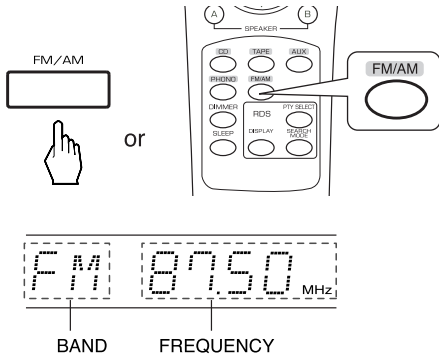

- Each time this button is pressed, the band is changed to FM or AM.

2. Select the tuning mode.

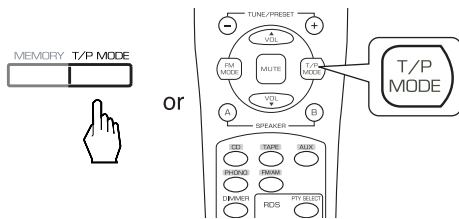

- Each time this button is pressed, the mode changes as follows:
  - Tuning mode : "PRESET" goes off.
  - ← Preset mode : "PRESET" lights up.

3. Press the TUNING/PRESET UP (▲/+) or DOWN (▼/-) button for more than 0.5 second.

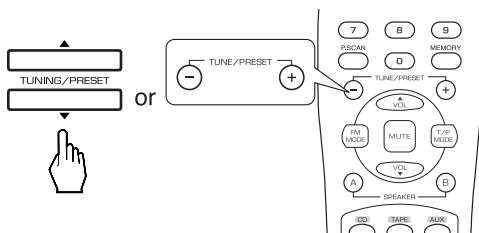

- The tuner will now search until a station of sufficient strength has been found. The display shows the tuned frequency and "TUNED".
- If the station found is not the desired one, simply repeat this operation.
- Weak stations are skipped during auto tuning.

## Manual tuning

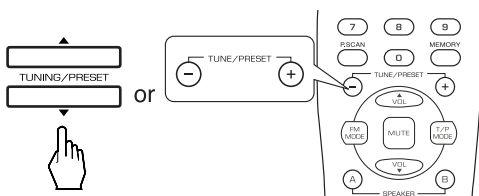

- Manual tuning is useful when you already know the frequency of the desired station.
- Perform the steps 1 and 2 in "Auto tuning" procedure and press the TUNING/PRESET UP (▲/+) or DOWN (▼/-) button repeatedly until the right frequency has been reached.

---

## Presetting radio stations

---

- You can store up to 30 preferred stations in the memory.

1. Tune in the desired station with auto or manual tuning.

---

2. Press the MEMORY button.

---

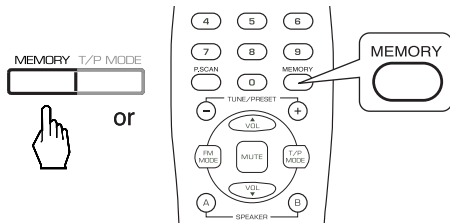

- “MEM” is flickering for 5 seconds.

3. Select the desired preset number (1~30) and press the MEMORY button.

---

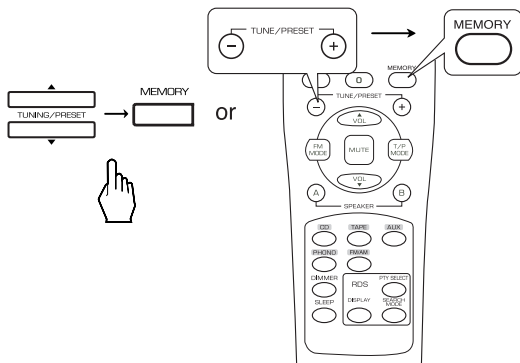

- When using the NUMERIC buttons on the remote control.

Examples) For “3” : (3)  
For “15” : (1)  $\xrightarrow{\text{within 2 seconds}}$  (5)  
For “30” : (0)

- The station has now been stored in the memory.
- When using the NUMERIC buttons, the station is stored automatically without pressing the MEMORY button.
- A stored frequency is erased from the memory by storing another frequency in its place.
- If “MEM” goes off, start again from the above step 2.

4. Repeat the above steps 1 to 3 to memorize other stations.

---

### ■ MEMORY BACKUP FUNCTION

The following items, set before the receiver is turned off, are memorized.

- INPUT SELECTOR settings
- Preset stations, etc.

### ■ Note

- If the electricity fails or the AC input cord is disconnected for more than several days, they are all cleared. So you should memorize them again.

## Tuning to preset stations

1. After selecting the tuner as an input source, select the preset mode.

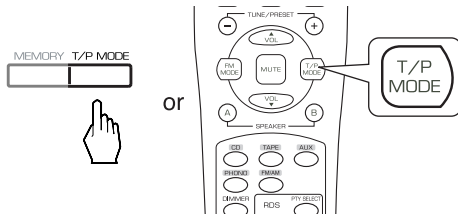

- Then "PRESET" lights up.

2. Select the desired preset number.

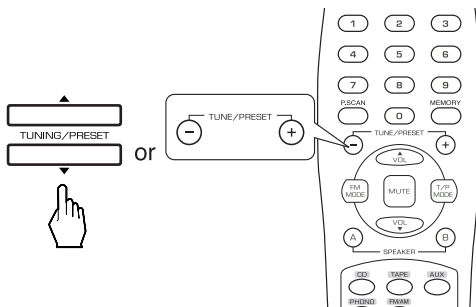

- When using the NUMERIC buttons on the remote control.

Examples) For "3" :

For "15" : within 2 seconds →

For "30" :

- When selecting the desired preset number with the NUMERIC buttons, the desired preset station will be tuned to automatically without selecting the preset mode.

## Listening to FM stereo broadcasts

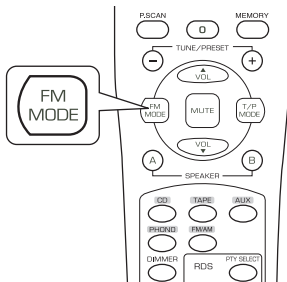

- While listening to FM broadcasts, press the FM MODE button.
- Each time this button is pressed, the FM mode changes as follows:

↳ Stereo mode : "ST" lights up.   
 ↳ Mono mode : "ST" goes off.

- When FM stereo broadcasts are poor because of weak broadcast signals, select the FM mono mode to reduce the noise, then FM broadcasts are reproduced in monaural sound.

## Scanning preset stations in sequence

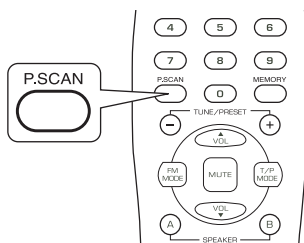

- The receiver will start scanning the stations in the preset sequence.
- At the desired station, press this button again to stop scanning.



# RDS Tuner (Regional Option for some countries in Europe, etc.) \_\_\_\_\_

## LISTENING TO RDS BROADCASTS (FM ONLY)

RDS (Radio Data System) is a method for sending information signals together with the transmitter signals. Your tuner is capable of translating these signals and putting the information on the display.

These codes contain the following informations. Program Service name(PS), A list of Program Types(PHY), Traffic Announcement(TA), Clock Time(CT), Radio Text(RT).

■ Note :

- In the other countries, RDS tuner function can not be available.

### RDS Search

- Use this function to automatically search and receive the stations offering RDS services.

1. In the FM mode, select the RDS search mode.

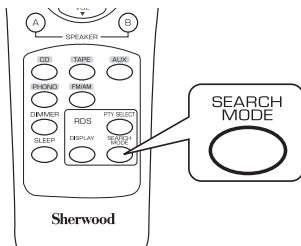

- Each time this button is pressed, the search mode changes as follows;

→ RDS SRCH → TP SRCH → PHY SRCH → OFF

2. When "RDS SRCH" is displayed, press the TUNING/PRESET UP(▲/+) or DOWN (▼/-) button.

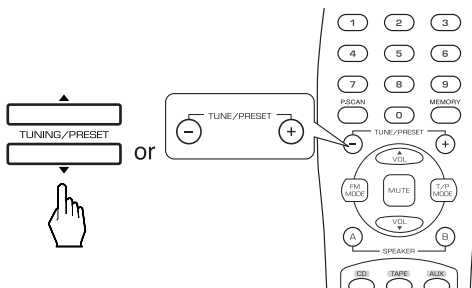

- The tuner automatically searches stations offering RDS services and the station name is displayed.
- If no other RDS station is found, "NO RDS" is displayed.
- When "RDS SRCH" is not displayed, repeat again from the above step 1.

---

## TP Search

---

- Use this function to automatically search and receive the stations broadcasting the traffic program.

1. In the FM mode, press the SEARCH MODE button twice.

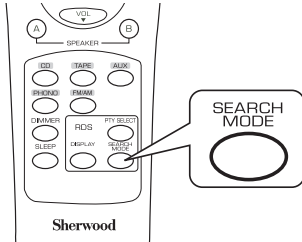

- "TP SRCH" is displayed.

2. When "TP SRCH" is displayed, press the TUNING/PRESET UP(▲/+) or DOWN (▼/-) button to search the station.

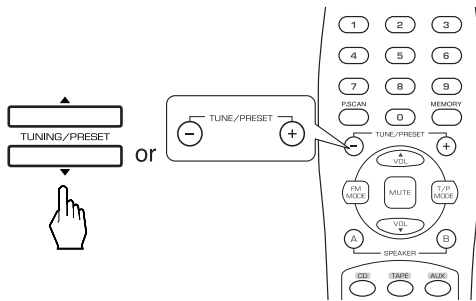

- The tuner automatically searches for stations broadcasting the traffic program.
- "NO TP" is displayed if the signal is too weak or there are no stations broadcasting the traffic program.
- When "TP SRCH" is not displayed, repeat again from the above step 1.

---

## PTY Search

---

- Use this function to automatically search and receive the stations broadcasting the desired program type.

1. In the FM mode, press the SEARCH MODE button three times.

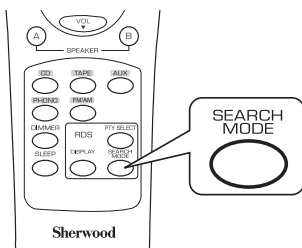

- "PTY SRCH" is displayed.

2. When "PTY SRCH" is displayed, press the PTY SELECT button to select the desired program type.

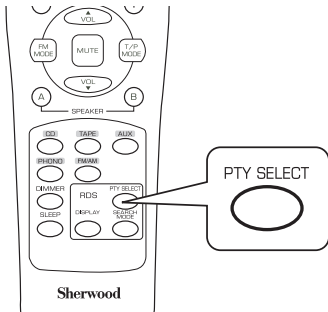

- Each time this button is pressed, one of 32 different types of programs is selected.

(NEWS, AFFAIRS, INFO, SPORT, EDUCATE, DRAMA, CULTURE, SCIENCE, VARIED, POP M, ROCK M, EASY M, LIGHT M, CLASSICS, OTHER M, WEATHER, FINANCE, CHILDREN, SOCIAL, RELIGION, PHONE IN, TRAVEL, LEISURE, JAZZ, COUNTRY, NATION M, OLDIES, FOLK M, DOCUMENT, TEST, ALARM, NONE)

- When "PTY SRCH" is not displayed, repeat again from the above step 1.

3. When the selected program type is displayed, press the TUNING/PRESET UP(▲/+) or DOWN (▼/-) button to search the station.

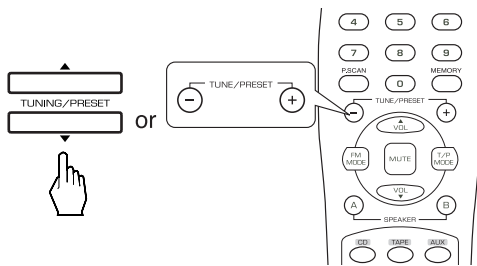

- The tuner automatically searches stations offering PTY services.
- If no station is found, "NO PTY" is displayed.

## DISPLAY

In the FM mode,

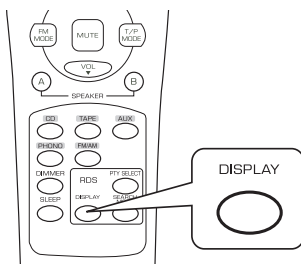

- Each time this button is pressed, the display mode changes as follows;

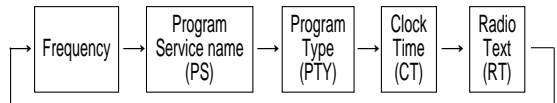

- If the signals are too weak or no RDS service is available, "NO NAME", "NO PTY", "NO TIME" or "NO TEXT" will be displayed.

## RECORDING

- The volume, tone(bass, treble) and balance settings have no effect on the recording signals.
- When you select tuner, CD or PHONO as a recording source, recording may be made on TAPE or AUX, or both simultaneously.

### Recording with TAPE

1. Select the desired input as a recording source except for TAPE.

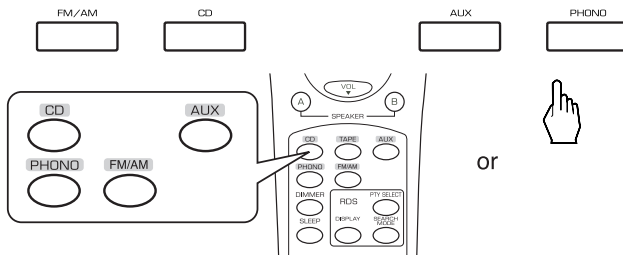

2. Start recording on the TAPE.

3. Start play on the desired input.

### Recording with AUX

1. Select the desired input as a recording source except for AUX.

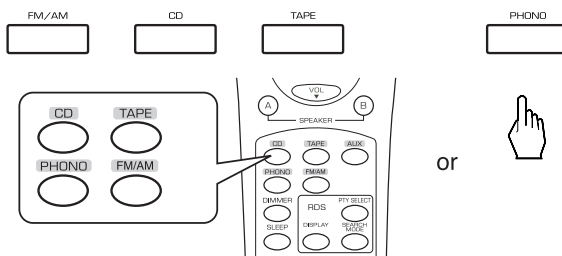

2. Start recording on the AUX.

3. Start play on the desired input.

## OTHER FUNCTIONS

### Operating the sleep timer

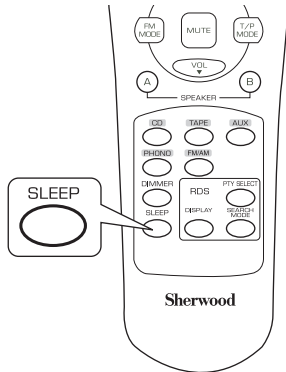

- The sleep timer allows the system to continue to operate for a specified period of time before automatically shutting off.
- To set the receiver to automatically turn off after the specified period of time.
- Each time this button is pressed, the sleep time changes as follows:

→ 10 → 20 → 30 → 60 → 90 → OFF  
Unit : minutes

- While operating the sleep timer, “★” lights up.
- When the sleep time is selected, all display panels of Sherwood components connected by the DIGI-LINK III are dimly lit.

### Adjusting the brightness of the fluorescent displays

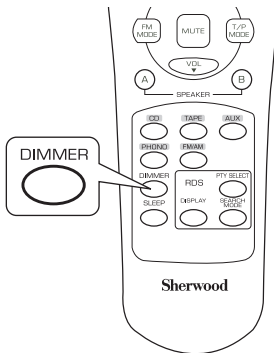

- Each time this button is pressed, the brightness of all fluorescent displays of Sherwood components connected by the DIGI-LINK III changes together as follows:

→ ON → dimmer → OFF

- In the display OFF mode, pressing any button will restore the display ON mode.

# Troubleshooting Guide

If a fault occurs, run through the table below before taking your receiver for repair. If the fault persists, attempt to solve it by switching the receiver off and on again. If this fails to resolve the situation, consult with your dealer. Under no circumstances should you repair the receiver yourself as this could invalidate the warranty.

PROBLEM	POSSIBLE CAUSE	REMEDY
No power	<ul style="list-style-type: none"> <li>• The AC input cord is disconnected.</li> <li>• Poor connection at AC wall outlet or the outlet is inactive.</li> </ul>	<ul style="list-style-type: none"> <li>• Connect the cord securely.</li> <li>• Check the outlet using a lamp or another appliance.</li> </ul>
No sound	<ul style="list-style-type: none"> <li>• The speaker cords are disconnected.</li> <li>• The volume is adjusted too low.</li> <li>• The MUTE button on the remote control is pressed to ON.</li> <li>• Speakers are not switched on.</li> <li>• Incorrect selection of the input source.</li> <li>• Incorrect connections between the components.</li> </ul>	<ul style="list-style-type: none"> <li>• Check the speaker connections.</li> <li>• Adjust the volume.</li> <li>• Press the MUTE button to cancel the muting effect.</li> <li>• Press the SPEAKER A or B button to ON.</li> <li>• Select the desired input source correctly.</li> <li>• Make connections correctly.</li> </ul>
Stations cannot be received	<ul style="list-style-type: none"> <li>• No antenna is connected.</li> <li>• The desired station frequency is not tuned in.</li> <li>• The antenna is in wrong position.</li> </ul>	<ul style="list-style-type: none"> <li>• Connect an antenna.</li> <li>• Tune in the desired station frequency.</li> <li>• Move the antenna and retry tuning.</li> </ul>
Preset stations cannot be received	<ul style="list-style-type: none"> <li>• An incorrect station frequency has been memorized.</li> <li>• The memorized stations are cleared.</li> </ul>	<ul style="list-style-type: none"> <li>• Memorize the correct station frequency.</li> <li>• Memorize the stations again.</li> </ul>
Poor FM reception	<ul style="list-style-type: none"> <li>• No antenna is connected.</li> <li>• The antenna is not positioned for the best reception.</li> </ul>	<ul style="list-style-type: none"> <li>• Connect an antenna.</li> <li>• Change the position of the antenna.</li> </ul>
Continuous hissing noise during FM reception, especially when a stereo broadcast is received.	<ul style="list-style-type: none"> <li>• Weak signals.</li> </ul>	<ul style="list-style-type: none"> <li>• Change the position of the antenna.</li> <li>• Install an outdoor antenna.</li> </ul>
Continuous or intermittent hissing noise during AM reception, especially at night.	<ul style="list-style-type: none"> <li>• Noise is caused by motors, fluorescent lamps or lightning, etc.</li> </ul>	<ul style="list-style-type: none"> <li>• Keep the receiver away from noise sources.</li> <li>• Install an outdoor AM antenna.</li> </ul>
No recording	<ul style="list-style-type: none"> <li>• Incorrect selection between the components.</li> <li>• Incorrect operation of each component for playback and recording.</li> </ul>	<ul style="list-style-type: none"> <li>• Make connections correctly.</li> <li>• Operate each component correctly.</li> </ul>
Remote control unit does not operate.	<ul style="list-style-type: none"> <li>• Batteries are not loaded or exhausted.</li> <li>• The remote sensor is obstructed.</li> </ul>	<ul style="list-style-type: none"> <li>• Replace the batteries.</li> <li>• Remove the obstacle.</li> </ul>

# Specifications

---

## ■ AMPLIFIER SECTION

- Power output, stereo mode, 8  $\Omega$ , THD 0.08 %, 20 Hz~20 kHz ..... 2X100 W
- Total harmonic distortion, 8  $\Omega$ , 100 W, 20 Hz~20 kHz ..... 0.04 %
- Intermodulation distortion  
60 Hz : 7 kHz= 4 : 1 SMPTE, 8  $\Omega$ , 100 W ..... 0.02 %
- Input sensitivity, 47 k $\Omega$   
Phono(MM) ..... 2.5 mV  
Line(CD,TAPE,AUX) ..... 200 mV
- Signal to noise ratio, IHF "A" weighted  
Phono(MM) ..... 70 dB  
Line(CD,TAPE,AUX) ..... 95 dB
- Frequency response  
Phono(MM), RIAA, 30 Hz~20 kHz .....  $\pm 3$  dB  
Line(CD,TAPE,AUX), 20 Hz~100 kHz .....  $\pm 3$  dB
- Output level  
TAPE/AUX OUT, 2.2 k $\Omega$  ..... 200 mV
- Bass/Treble control, 100 Hz/10 kHz .....  $\pm 10$  dB

## ■ FM TUNER SECTION

- Tuning frequency range ..... 87.5~108 MHz
- Usable sensitivity, THD 3%, S/N 26 dB ..... 15 dBf
- 46 dB quieting sensitivity, mono/stereo ..... 25.2/45.2 dBf
- Signal to noise ratio, 65 dBf, mono/stereo ..... 68/65 dB
- Total harmonic distortion, 65 dBf, 1 kHz, mono/stereo ..... 0.5/0.8%
- Frequency response, 20 Hz~14 kHz .....  $\pm 3$  dB
- Stereo separation, 1 kHz ..... 40 dB
- Capture ratio ..... 4 dB
- IF rejection ratio ..... 80 dB

## ■ AM TUNER SECTION

- Tuning frequency range ..... 522~1611 kHz
- Usable sensitivity ..... 800  $\mu$ V/m
- Signal to noise ratio ..... 40 dB
- Selectivity ..... 25 dB

## ■ GENERAL

- Power supply ..... 230 V~ 50 Hz
- Power consumption ..... 330 W
- Switched AC outlet ..... Total 100 W (0.43A) max.
- Dimensions (W  $\times$  H  $\times$  D, including protruding parts) ..... 440  $\times$  138  $\times$  370mm(17-3/8  $\times$  5-7/16  $\times$  14-9/16 inches)
- Weight (Net) ..... 8.85 kg(19.5 lbs)

Note: Design and specifications are subject to change without notice for improvements.